

Empowering your business, one transaction at a time.

Innovative payment solutions delivered with a personal touch.

Accept payment in-person or online with our innovative terminal solutions. Whether you need a stationary, wireless, mobile, or virtual terminal, a payment gateway, or software integration, ECS is the right choice for you.



Diverse solutions for every scenario.



Credit & Debit

With a diverse range of credit and debit card processing solutions, we have what you need.



ACH

Completely electronic, ACH transactions are efficient and low-cost.



ATM

Connect to all major ATM networks.



Banking

With a merchant bank account, you'll have access to our affordable rates and award-winning merchant services team.



High-Risk

We're built to handle complex merchants, regardless of your industry.



Lending

Lending your way to provide you with the instant capital you need.



Merchant Cash Advance

Access the assets your business deserves.



Remote Deposit Capture

With ECS, there's no need to go to the bank to cash payment checks.

To find out more [click here](#)





P200/P200 Plus

Installation Guide



P200/P200 Plus Installation Guide
© 2016 Verifone, Inc.

All rights reserved. No part of the contents of this document may be reproduced or transmitted in any form without the written permission of Verifone, Inc.

The information contained in this document is subject to change without notice. Although Verifone has attempted to ensure the accuracy of the contents of this document, this document may include errors or omissions. The examples and sample programs are for illustration only and may not be suited for your purpose. You should verify the applicability of any example or sample program before placing the software into productive use. This document, including without limitation the examples and software programs, is supplied "As-Is."

Verifone and the Verifone logo, are registered trademarks of Verifone. Other brand names or trademarks associated with Verifone's products and services are trademarks of Verifone, Inc.

All other brand names and trademarks appearing in this manual are the property of their respective holders.

Product Warranty

For product warranty information, go to <http://www.verifone.com/terms>.

Comments? Please e-mail all comments on this document to your local Verifone Support Team.

Verifone Inc.
1-800-Verifone
www.verifone.com

Verifone Part Number DOC430-003-EN-B, Revision B



CONTENTS

- PREFACE** 5
 - Audience 5
 - Organization 5
 - Related Documentation 5
 - Guide Conventions 6
 - Acronym Definitions 6

- CHAPTER 1**
 - Overview** P200 9
 - Front Functions 9
 - Back Functions 10
 - Features and Benefits 10

- CHAPTER 2**
 - Setup** Selecting Location 11
 - Environmental Factors 11
 - Electrical Considerations 12
 - Contactless Considerations 12
 - PIN Protection Measures 12
 - Ensuring User Privacy 13
 - Unpacking Shipping Carton 13
 - MSAM/uSD Cards 14
 - Installing or Changing MSAM/uSD Card. 14
 - Power Supply 15
 - USB Power Supply 15
 - Cable Connections 16
 - Attaching a Cable Connector to the P200 16
 - Connection to Another Verifone Terminal. 16
 - RS-232 Connection Using an External Power Brick. 19
 - Direct USB Connection 20
 - Powered USB Connection 20
 - Ethernet Connection with External Power Brick 21
 - Smart Card Reader 22
 - Magnetic Stripe Card Reader Use 22
 - Contactless Transactions 23
 - Optional Accessories 23
 - Privacy Shield 23
 - Stylus and Holder 25
 - Mounting Plate 25
 - Periodic Inspection 26

- CHAPTER 3**
 - Specifications** Unit Power Requirements. 27
 - Temperature 27
 - Humidity 27

	External Dimensions	27
	Weight	27
	Processor	27
	Display	27
	Magnetic Card Reader	27
	Primary Smart Card	27
	SAM Card Reader	28
	Security	28
CHAPTER 4		
Troubleshooting	Display Panel Does Not Work	29
Guidelines	Keypad Does Not Respond	29
	Transactions Fail To Process	29
CHAPTER 5		
Service and Support	Maintenance and Cleaning	31
	Service Returns	31
	Decommissioning/Removal From Service	32
	Accessories and Documentation	33
	Cables	34
	Power Supply	34
	Privacy Shield	34
	Mounting Plate	34
	Cleaning Kit	34
	Documentation	34
APPENDIX A	Caution and Warning Messages	35



This guide is the primary source of information for setting up and installing a P200 device.

Audience

This guide provides simple descriptions of the P200 features, as well as basic information for installing and configuring the P200.

Organization

This guide is organized as follows:

[Chapter 1, Overview](#). Provides an overview of a P200 device.

[Chapter 2, Setup](#). Explains how to set up and install the P200, as well as to establish connections with other devices.

[Chapter 3, Specifications](#). Discusses the power requirements and dimensions of P200.

[Chapter 4, Troubleshooting Guidelines](#). Provides troubleshooting tips.

[Chapter 5, Service and Support](#). Provides information on contacting your Verifone service provider, ordering accessories or documentation from Verifone, and maintaining the P200 unit.

[Appendix A, Caution and Warning Messages](#). Shows the UL/cUL certification-compliant translations of all Warning and Caution messages in this installation guide.

Related Documentation

To learn more about the P200 device, please refer to the following documents and their associated Verifone Part Numbers (VPN):



<i>P200 and P200 Plus Certifications and Regulations</i>	VPN DOC430-001-EN
<i>P200 Quick Installation Guide</i>	VPN DOC430-002-EN
<i>P200/P400 Reference Guide</i>	VPN DOC435-004-EN
<i>Engage Low-Profile Privacy Shield Quick Installation Guide</i>	VPN DOC000-020-EN
<i>Engage Standard Privacy Shield Quick Installation Guide</i>	VPN DOC000-020-01
<i>P200/P400 Mounting Adapter Quick Installation Guide</i>	VPN DOC435-007-EN

Guide Conventions

Please refer to the following document conventions for quickly identifying special formatting.

Table 1 describes these conventions and provides examples of their use.

Table 1 Document Conventions

Convention	Meaning	Example
Blue	Text in blue indicates terms that are cross-references.	See Guide Conventions .
<i>Italics</i>	Italic typeface indicates book titles or emphasis.	You <i>must</i> not use this unit underwater.
NOTE 	The pencil icon is used to highlight important information.	RS-232-type devices do not work on the P200 communication port.
CAUTION 	The caution symbol indicates hardware or software failure, or loss of data.	The unit is not waterproof or dustproof, and is intended for indoor use only.
WARNING 	The lightning symbol is used as a warning when bodily injury might occur.	Due to risk of shock do not use the unit near water.

Acronym Definitions

Please refer to Table 2 for the acronyms used in this manual.

Table 2 Acronym Definitions

Acronym	Definitions
3DES	Triple Data Encryption Algorithm
AC	Alternating Current
ANSI	American National Standards Institute
cUL	Underwriters' Laboratories of Canada
DC	Direct Current
DUKPT	Derived Unique Key Per Transaction Method as defined in the VISA's <i>POS Equipment Requirement: PIN processing and Data Authentication</i> , International Version 1.0, August 1988
ECR	Electronic Cash Register
EMV	Europay, MasterCard, and Visa
ISO	International Organization for Standardization
MRA	Merchandise Return Authorization
MSAM	Multiple Secure Access Module
LAN	Local Area Network
LCD	Liquid Crystal Display
LED	Light-Emitting Diode
PED	PIN Entry Device

Table 2 **Acronym Definitions** (continued)

Acronym	Definitions
PIN	Personal Identification Number
POS	Point-of-Sale
RS-232	Recommend Standard number 232
SAM	Secure Access Module
UL	Underwriters Laboratories
USB	Universal Serial Bus
VPN	Verifone Part Number



Overview

This chapter describes and introduces the features of P200.

P200 The P200 is Verifone's next generation integrated retail PINpad device. Its functionality and sophisticated design is perfect for small to medium retail establishments.

The P200 is a consumer facing handheld device. It can also be fix-mounted in some integrated retail scenarios. The product's design is equally appealing as a handheld PINpad and robust enough to look and function appropriately in a fixed mount setting.



Figure 1 P200

Front Functions The P200 includes the following features:

- 2.8" QVGA color display.
- Secure keypad supporting 3 x 5 matrix containing 0-9, *, #, Cancel, Backspace/Clear, and Enter keys. It also supports PF1 and PF2 function keys and a navigation key.
 - Supports **telco-style format**
 - Dual-function Backspace/Clear key.
 - Customer-entry for Cancel and Enter keys.
 - Backlight support.
 - Audible audio key-press.

Back Functions The rear of the P200 device shows the following:

- **Cable connector compartment.**
- **Threaded grommets** for attaching the mounting plate.
- A dual-stack **MSAM connectors** built into the back of the unit to support stored-value card programs or other merchant card requirements.
- A **uSD connector** on P200 Plus units.

Features and Benefits

Exceptional Ease of Use and Ergonomics

- Sleek and stylish shape occupies minimal counter space.
- Bold, ergonomic design fits comfortably in the palm of a hand.
- Large, hard-rubber keys provide improved tactile feedback, minimizing errors and maximizing ease-of-use for consumers of all ages.
- Intuitive telco-style interface and colored control keys simplify training and reduce support requests.
- 240 (RGB) x 320 TFT (QVGA) display.
- Total memory of 384 MB (256 MB Flash and 128 MB DDR3) for P200, and total memory of 1 GB (512 MB Flash and 512 MB DDR3) for P200 Plus.
- Rugged and reliable design.
- Connects with most POS payment terminals.
- Supports payment transactions in a variety of payment environments.

Critical Security Protection

- Offers a choice of Master/Session or DUKPT key-management methods to protect PIN-based transactions.
- Offers secure, reliable PIN input for expanding range of PIN-based transactions.
- PCI-compliant for secure solutions, meeting the PED standard.
- Meets ISO and ANSI standards for PIN encryption, key management, and MAC.
- Key injection simplified and secured with Verifone's SecureKit key loading software.
- Rugged and reliable design absorbs hard knocks found at point-of-sale counters.
- Removable privacy shield offers option of supplemental physical security.
- Connects with most POS payment terminals, PCs, and ECRs.
- USB Connectivity that gives another option to connect with payment terminals, personal computers, and electronic cash registers (ECRs).

Setup

This chapter describes the setup procedure for the P200, in the following sections:

- Selecting Location
- PIN Protection Measures
- Unpacking Shipping Carton
- MSAM/uSD Cards
- Power Supply
- Cable Connections
- Smart Card Reader
- Magnetic Stripe Card Reader Use
- Contactless Transactions
- Optional Accessories

Selecting Location

Use the following guidelines to select the best location for the P200 device.

To Select a Location

Choose a location convenient for both merchant and client:

- Far from heavy metal objects,
- A flat support surface---such as a countertop or table,
- Near a power outlet and the terminal or computer that connects to the P200.

WARNING



For safety, do not string cables or cords across a walkway.

Environmental Factors

- Do not use the unit where there is high heat, dust, humidity, moisture, or caustic chemicals or oils.
- Keep the unit away from direct sunlight and anything that radiates heat, such as a stove or a motor.
- Do not use the P200 outdoors.

CAUTION



The P200 is not waterproof or dustproof, and is intended for *indoor use only*. Any damage to the unit from exposure to rain or dust can void any warranty.

Electrical Considerations

- Avoid using this product during electrical storms.
- Do not use the P200 unit near water or in moist conditions.
- Disconnect the device from its POS terminal before cleaning.



Due to risk of electrical shock or terminal damage, do not use the terminal near water, including a bathtub, wash bowl, kitchen sink or laundry tub, in a wet basement, or near a swimming pool. Avoid using this product during electrical storms. Avoid locations near electrical appliances or other devices that cause excessive voltage fluctuations or emit electrical noise (for example, air conditioners, neon signs, high frequency or magnetic security devices, or electric motors).

Contactless Considerations

Avoid having metallic objects in proximity of the contactless antenna. If you need to mount the terminal to vertical or inclined surfaces, use a flat, non-metallic mounting plate.



Figure 2 Areas to Avoid Metal Contact



Using an enclosed metal frame or mount may negatively affect contactless performance.

PIN Protection Measures

Use the following techniques to provide effective screening of PIN-entry devices (PEDs) during the PIN entry process. You can use these methods in combination, although in some cases a single method might suffice.

- Position the terminal on the check-in stand in such a way as to block visual observation of the PIN-entry process. Examples include:
 - Visual shields designed into the check-in stand. The shields may be solely for shielding purposes, or may be part of the general check stand design.
 - Position the PED so that it is angled in such a way that PIN spying is difficult.

- Install the PED on an adjustable stand that allows consumers to swivel the terminal sideways and/or tilt it forwards/backwards to a position that makes visual observation of the PIN-entry process difficult.
- Position in-store security cameras so that the PIN-entry keypad is not visible.

The following table describes the two preferred mounting methods and the recommended measures to protect from PIN capture in four observation corridors:

Table 3 Mounting Methods and Protection Measures

Method	Cashier	Customer in Queue	Customers Elsewhere	On-site Cameras
Countertop without stand	Use signage behind the PED	Install so that customer is between PED and next in queue	No action needed	Do not install within view of cameras
Countertop with stand	No action needed	Install so that customer is between PED and next in queue	No action needed	Do not install within view of cameras

Verifone also recommends instruction of the cardholder regarding safe PIN-entry. This can be done with a combination of:

- Signage on the PED
- Prompts on the display, possibly with a click-through screen
- Literature at the point of sale
- A logo for safe PIN-entry process.

Ensuring User Privacy

Use the following guidelines to protect the user’s privacy when he enters his personal identification number (PIN):

- The area of visibility should be no larger than a cone taken from the number 5 key at an angle of 45° and covering an area of 270° directly in front of the user.
- You can secure PIN entry by installing a [Privacy Shield](#).

Unpacking Shipping Carton

Carefully inspect the shipping carton and its contents for possible tampering or damage.

- 1 Remove the P200 unit from the shipping carton. The standard package contains the PIN pad only and does not include any other cables or accessories. Refer to [Accessories and Documentation](#) for more information about P200-related accessories.



This device is a secure product and any tampering can cause it to cease to function or operate in an unsecured manner.

- 2 Remove any protective plastic wrap and place the unit on a table or countertop.

- 3 Remove the clear protective film from the display.
- 4 Replace all the packing materials, close the lid, and save the carton for repacking or moving the P200 unit in the future.



Do not use a unit that has been tampered with or otherwise damaged. This unit comes equipped with tamper-evident label. If a label or component appears damaged, immediately notify the shipping company and your Verifone representative or service provider.

MSAM/uSD Cards

You may need to install a uSD card or one or more multiple security access module (MSAM) cards or replace the old cards.

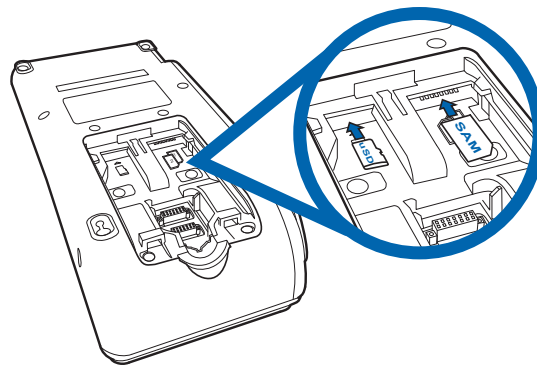

Figure 3 MSAM/uSD Slots



Observe standard precautions in handling electrostatically sensitive devices. Electrostatic discharges can damage the equipment. Verifone recommends using a grounded anti-static wrist strap.

Installing or Changing MSAM/uSD Card

To install or change uSD or MSAM card:

- 1 Place the terminal face down on a soft and clean surface to protect the lens from scratches.
- 2 Slide out and lift the compartment cover. The uSD and MSAM cardholders are now accessible.



The P200 supports two MSAM cards in a stacked configuration. P200 Plus features a uSD connector.

- 3 Install the uSD or MSAM card by carefully sliding it into the slot until fully inserted.



Insert the card with the card's gold contacts facing away from you, toward the unit.

Power Supply

Not all configurations and device contexts require the use of a power supply – Verifone ships power supply with the terminal as required.

Contact your Verifone representative if you have changed the context in which the terminal is used or have questions about which power supply should be used.



Using an incorrectly rated power supply can damage the unit or cause it not to work properly. Use only a power pack with VPN PWR435-001-01-A (see [Service and Support](#) for detailed power supply specifications).

Disconnect the power pack cord from the power outlet before connecting a power supply. Connect and route all cables between the terminal, ECR, and PC before plugging the power pack cord into a wall outlet or surge protector.



Do not plug the power pack into an outdoor outlet or operate the terminal outdoors. Disconnecting power during a transaction can cause transaction data files not yet stored in memory to be lost.



Verifone recommends installing a power surge protector to protect against possible damage caused by lightning strikes and electrical surges.

When the terminal has power and an application is loaded, the application starts after the initial Verifone copyright screen and displays a unique copyright screen. If no application is loaded, **DOWNLOAD NEEDED** appears on the display after the initial Verifone copyright screen.

USB Power Supply

P200 can be powered with 5 V supply from USB port (5V at 500 mA) with the following power-saving conditions controlled by OS:

- Maximum audio output volume is reduced.
- LCD backlight intensity is reduced to 30% (not suitable for high-glare, outdoor usage).
- Keypad backlight is disabled.
- Ethernet is unavailable.
- BT/Wi-Fi functions are unavailable.
- The maximum USB cable length supported is 4.1 m (CBL280-025-02-A).
- In CTLS payment mode, the micro-processor operating frequency is reduced to 300 MHz until the PINpad exits CTLS mode.

- Multi-media function (video playback or audio function) has to be switched off by user or customer app when CTLS payment mode is activated. Other modes of payment like smart card and MSR payment can be supported.



CTLS payment mode is defined as the state of the device where RF transmission is broadcasting to allow for a CTLS payment. This is activated either during the scanning of items or at the completion of scanning items during the checkout process, depending on how the application sets it up. As soon as checkout is complete, the device exits CTLS payment mode and remains off until activated for the next checkout.

Cable Connections

The P200 has several cabling scenarios, depending on what it connects to:

- 1 Connection to Another Verifone Terminal.
- 2 RS-232 Connection Using an External Power Brick.
- 3 Direct USB Connection.
- 4 Powered USB Connection.
- 5 Ethernet Connection with External Power Brick.



Turn off or unplug the terminal when connecting or disconnecting the device to avoid device memory corruption and data loss. Refer to the controlling device instructions for any terminal-specific warnings.

Attaching a Cable Connector to the P200

Before going into each cabling scenario, the cables first have to be attached to the P200. Follow steps 1-2 in [Installing or Changing MSAM/uSD Card](#) section to open the compartment door then attach the 28-pin connector of the cable to the terminal.

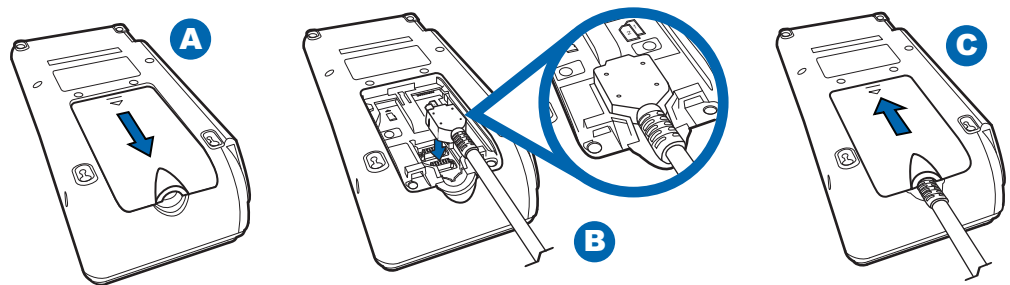

Figure 4 Using the 28-Pin Connector

Connection to Another Verifone Terminal

P200 can be powered by another terminal in two ways:

- Serial Connection
- USB Connection

Serial Connection

- **Configuration 1 - P200 to V200c**

Connect the 28-pin connector of the coiled serial cable (VPN - CBL282-036-01-A) to P200, then insert the other end of the cable to the multi-communication port of V200c. There is a minimum power requirement for the terminal, currently specified at 5.2 W.

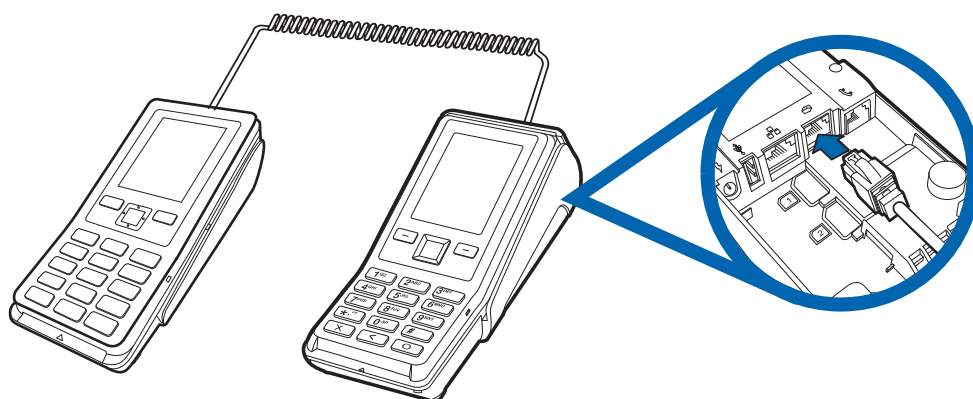

Figure 5 Connecting to V200c

- **Configuration 2 - P200 to VX 520**

Connect the 28-pin connector of the coiled serial cable (VPN - CBL282-036-01-A) to P200, then insert the other end of the cable to the RS-232 port of VX 520.

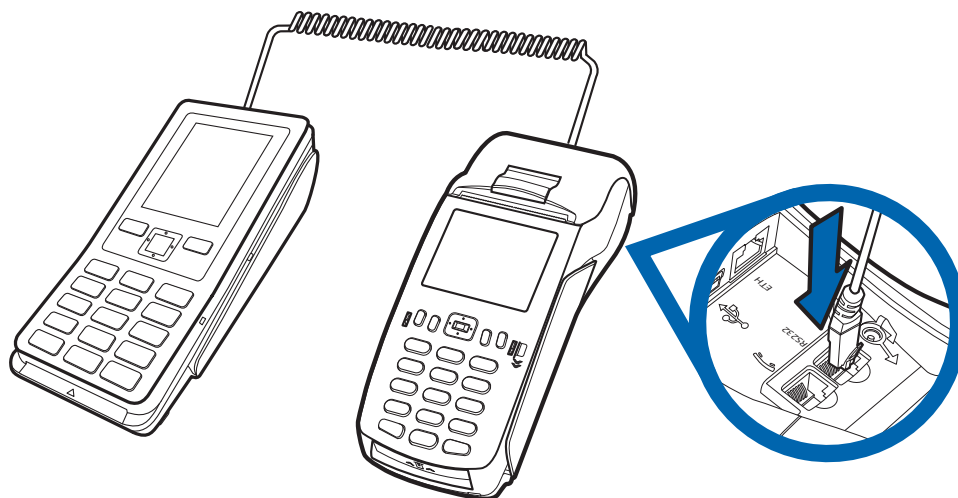

Figure 6 Connecting to VX 520

- **Configuration 3 - P200 Plus to VX 520**

In order for the P200 Plus to support full-feature without any limitation, it is required to power the PINpad with an external power supply.

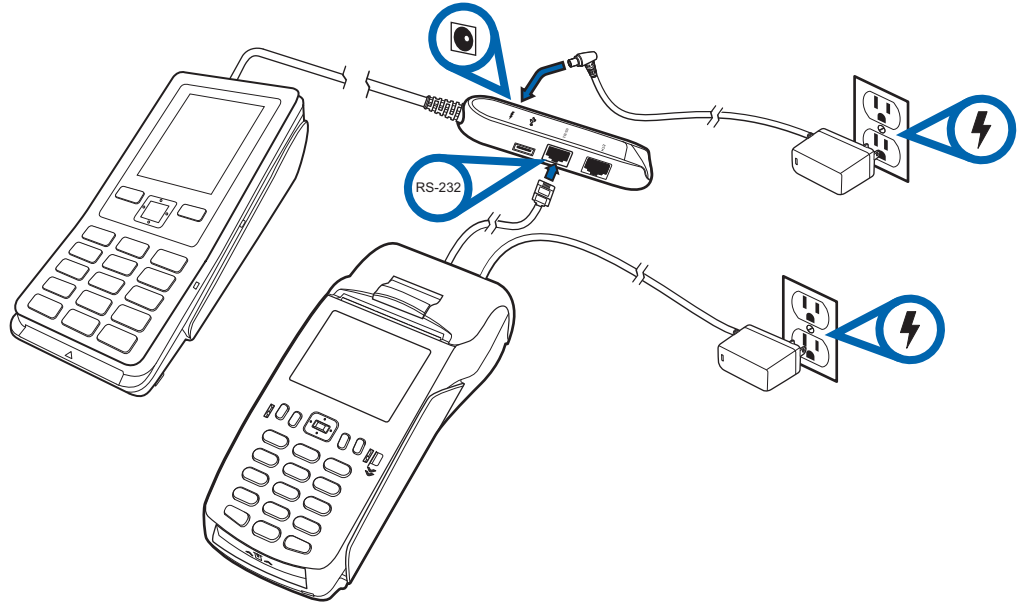

Figure 7 Powering PINpad with External Power Supply

USB Connection

- **Configuration 1 - P200 to V200c**

P200 can be powered up by V200c via the USB port. Connect the USB cable CBL282-038-xx-A directly to the USB1 (USB Vertical Type A) port of V200c.

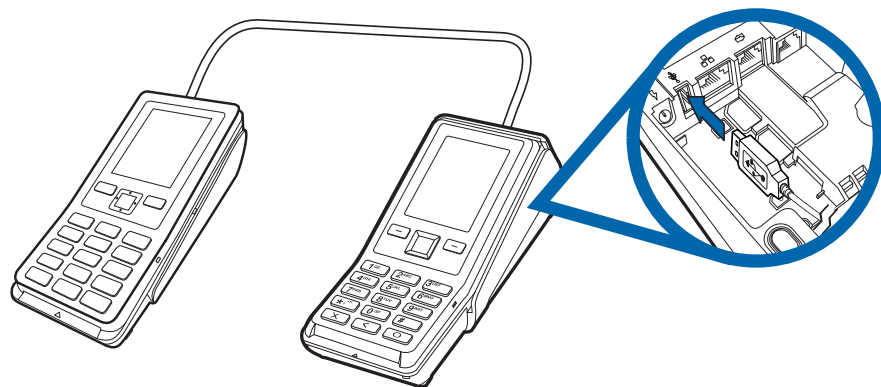

Figure 8 Connecting to V200c Via USB



NOTE

Do not connect to USB0 via MOD10 port of V200c through splitter cable to power up the unit as the current limit is set to only 500 mA.

- **Configuration 2 - P200 to V200c**

P200 can be powered via the V200c multi-communication port of V200c, which also supports USB connectivity. Insert the USB cable CBL435-002-01-A directly to the multi-communication port of V200c.

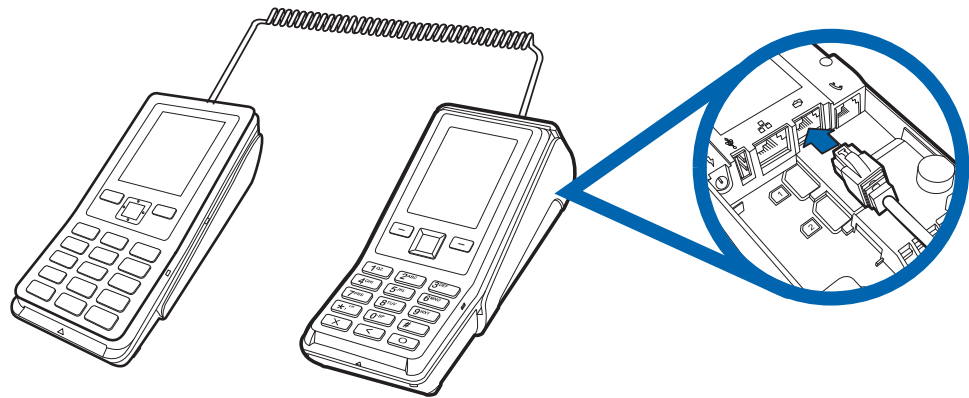

Figure 9 Connecting to V200c via Serial

**RS-232 Connection
Using an External
Power Brick**

A special dongle cable is used, where one end of the cable plugs into the P200 while the other end terminates in a DB-9 connector housing. On the housing, a DC jack is provided to connect to an external power brick. This is a generic cable for all RS232-based hosts (VPN - CBL282-031-XX-A).

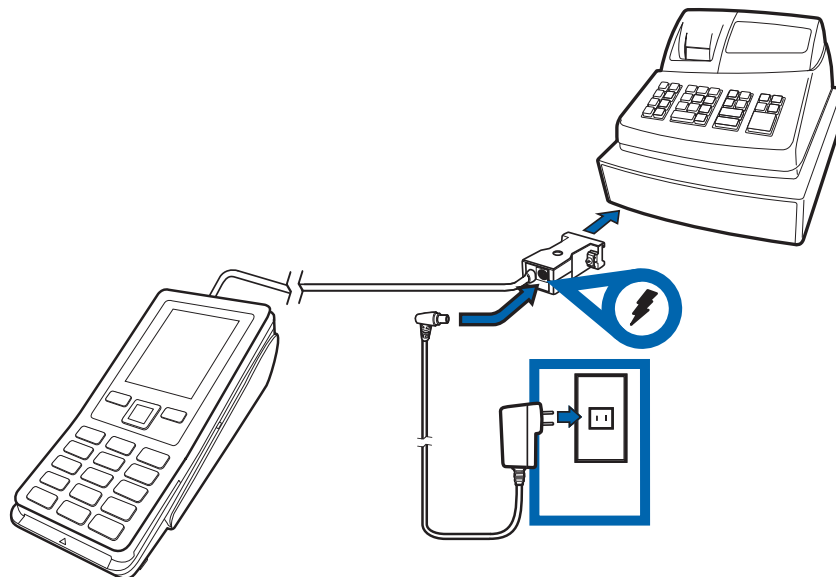

Figure 10 Connecting to RS232-Based Host

Direct USB Connection

Similarly, a USB cable (VPN - CBL282-038-XX-A) is required in standard USB environments. For this cable option, the host end has a molded housing which exposes the standard USB plug.

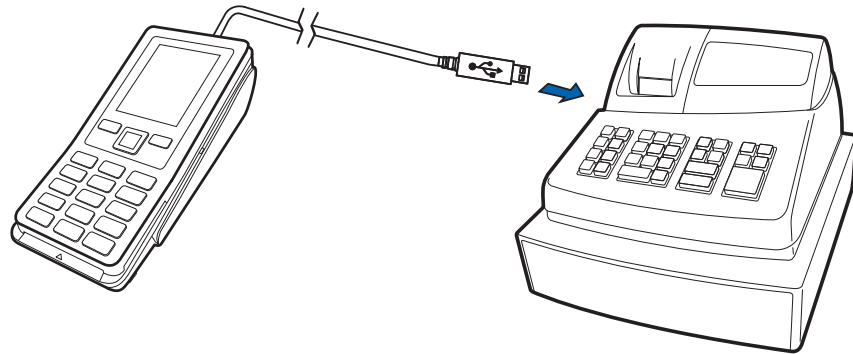

Figure 11 Connecting to USB-Based Host

Powered USB Connection

A PoweredUSB cable allows for devices to obtain power through their USB host instead of requiring an independent power supply or external AC adapter. Connect the cable (VPN - CBL282-033-01-A) to the P200 and plug the male USB connector into the corresponding USB port of the connecting device.

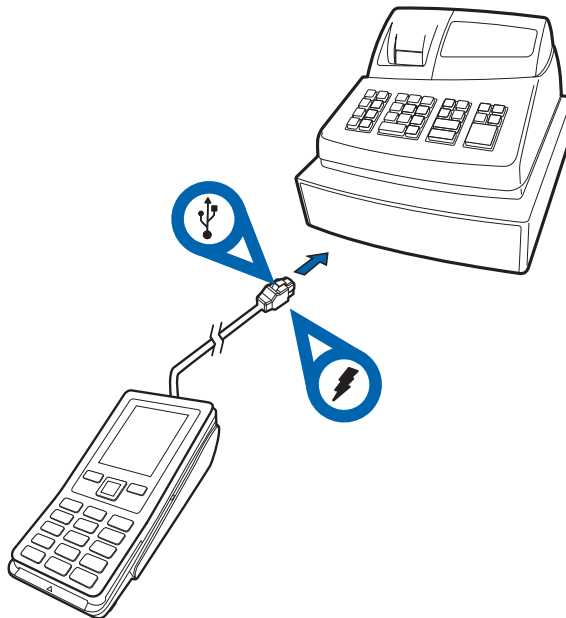

Figure 12 Connecting to USB-Based Host via Powered USB.



NOTE

There are two variants of PoweredUSB, one with 12 V DC output and another with 24 V DC. The P200 only supports 12 V DC option.



Incorrect power sequence may degrade the SoC Host port.

Ethernet Connection with External Power Brick

To connect the terminal to other devices via Ethernet, use the cable with a junction box that provides a standard RJ-45 LAN socket, a mini-USB port, and a standard DC jack for an external power connection.

The junction box comes in these configurations:

Cable	Configuration	Part Number
Ethernet with RS232	Junction box with RJ-45 socket (for connecting PINPad to LAN infrastructure), MOD-8 socket & DC-in jack	CBL282-006-01-B
Ethernet with RS232 and Mini USB option	Junction box with RJ-45 socket (for connecting PINPad to LAN infrastructure), MOD-8 socket, Mini USB & DC-in jack	CBL435-005-02-A
Ethernet with RS232 and Mini USB option	Junction box with RJ-45 socket (for connecting PINPad to LAN infrastructure), MOD-8 socket, Mini USB, type A USB & DC-in jack	CBL435-044-01-A

The figure below shows the connections available on the external power brick.

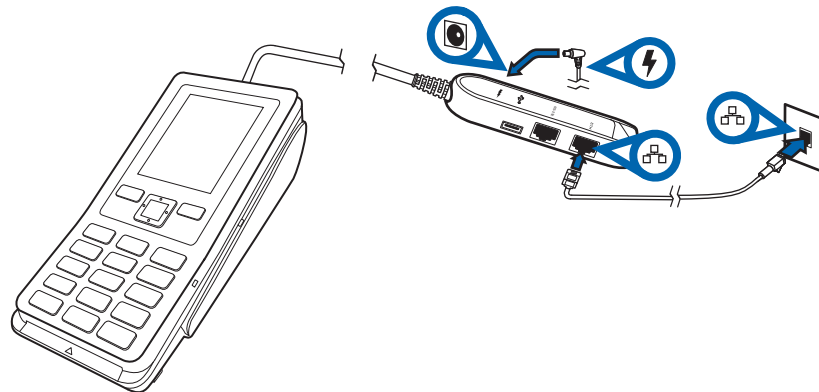

Figure 13 Available Connections on the External Power Brick

Smart Card Reader

The smart card transaction procedure can vary depending on the application. Verify the proper procedure with your application provider before performing a smart card transaction.

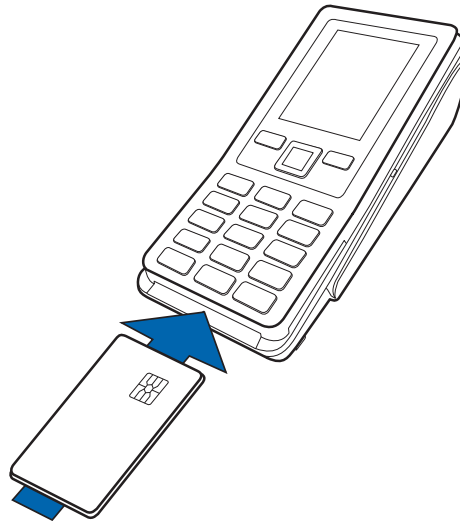

Figure 14 Using the Smart Card Reader

Conducting a Smart Card Transaction

To conduct a smart card transaction:

- 1 Position the smart card with the gold contacts facing upward.
- 2 Insert the card into the smart card reader slot in a smooth, continuous motion until it seats firmly.
- 3 Remove the card when the display indicates the transaction is completed.



Leave the smart card in the card reader until the transaction is completed. Premature removal can void the transaction.

Magnetic Stripe Card Reader Use

The P200 has a magnetic card reader that uses a triple track stripe reader. This gives the unit greater reliability over a wide range of swipe speeds and operating environments.

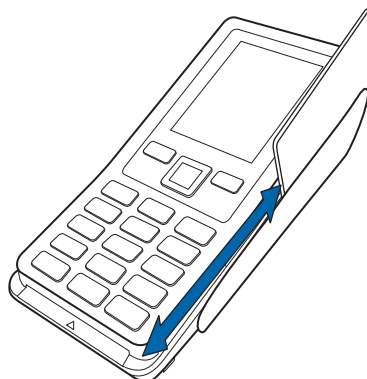

Figure 15 Using the Magnetic Stripe Card Reader

Conducting a Credit/ Debit Card Transaction

To conduct a credit or debit card transaction:

- 1 Position a magnetic card with the stripe facing the keypad.
- 2 Swipe it through the magnetic card reader.

Contactless Transactions

The P200 supports contactless transactions through an integrated contactless module. The terminal only becomes active for contactless smart card transactions when initialized by an application.



Figure 16 Contactless Transaction

Performing Contactless Transactions

To perform a contactless smart card transaction:

- 1 Gently tap the card onto or hold the card (within 4 cm) against the surface of the display where the contactless logo appears.
- 2 An activated LED visual on the display accompanied by a short beeping sound indicates a successful transaction.

See [Contactless Considerations](#) for more information.

Optional Accessories

These accessories can be used to further enhance the device's functionality. See [Service and Support](#) for additional information.

Privacy Shield

The privacy shield is used to hide the keys when entering user password in a transaction. Two types of privacy shields can be used:

- Standard Type - This privacy shield is PCI-compliant. This must be used when P200 is not mounted on a swivel stand.



Figure 17 Standard Type Privacy Shield



NOTE

Failure to use the privacy shield in PCI-compliant manner will void compliance for the affected device.

- Half-height Type - This privacy shield is not PCI-compliant. This may only be used when P200 is mounted on a swivel stand.



Figure 18 Half-height Type Privacy Shield

Installing the Privacy Shield

To install a privacy shield:

- 1 Align the hooks on the privacy shield with the corresponding slots beside the keypad on the terminal.
- 2 Once the hooks are in place, gently push down on the privacy shield until it snaps into place.

Stylus and Holder A stylus with holder can be attached to P200 and used as an alternative device input method.

Attaching the Stylus Holder To attach the stylus:

- 1 Align the stylus holder's screw holes with those found on the back of the terminal.
- 2 Screw the holder onto the back of the terminal.

Mounting Plate This accessory is used to mount P200 to vertical or inclined surfaces.

Attaching a Mounting Plate to P200 To attach a mounting plate to P200:

- 1 Align the screw holes at the back of the terminal with the corresponding screws on the mounting plate (this can be done with or without the stylus holder attached).
- 2 Screw the mounting plate in place, keeping the terminal aligned.

Mounting P200 with Mounting Plate to a Wall or Flat Surface To mount the terminal to a wall or flat surface:

- 1 Ensure the mounting plate is attached to the terminal.
- 2 Attach three M3 screws (not included in P200 package) to the desired surface. Make sure that they are aligned with the slots on top and at the bottom of the mounting plate.
- 3 Secure the terminal with the mounting plate in place by aligning the holes to the M3 screws then sliding the entire assembly into place.
- 4 Slide the terminal down to secure it to the mounting plate. To remove the terminal, slide the terminal up and pull away from the mounting plate.

Mounting P200 to a Flat Surface (Without a Mounting Plate) To mount the terminal to a flat surface:

- 1 Align the terminal's footers to the holes on the mounting plate.
- 2 Fit the footers of the terminal into the footer holes.
- 3 Screw the mounting plate in place.



Customized plates must have four recessed areas big enough to fit the footers of the terminal. This ensures that there is no gap between the terminal and mounting plate.

Mounting P200 with Mounting Plate to a Vertical Bracket To mount the terminal with a mounting plate to a vertical bracket:

- 1 Ensure the mounting plate is attached to the terminal.
- 2 Align the three screw holes of the mounting plate with the vertical bracket holes.
- 3 Screw the vertical bracket in place.

Mounting Considerations

Avoid having metallic objects in proximity to the contactless antenna. If you need to mount the terminal to vertical or inclined surfaces, use a flat mounting plate.



An enclosed metal frame or mount may negatively affect CTLS performance.

Periodic Inspection

Periodically inspect the terminal for possible tampering. Signs of tampering may include:

- Wires protruding from the device.
- Foreign objects inserted into the smart card or mag stripe slot.
- Signs of damage to the tamper-evident label.
- Warning message on the device display.



If any device is found in tamper state, please remove it immediately from service. Keep it available for potential forensic investigation, and notify your company security officer and your local Verifone representative or service provider. For more information on contacting Verifone, refer to [Service and Support](#).



Specifications

This chapter discusses power requirements, dimensions, and other specifications of the P200 device.

Unit Power Requirements

P200 and P200 Plus devices have the following power requirements:

- Full capability: 7-12 V DC, 1A
- Reduced capabilities (USB powered): 5 V DC, 500 mA

Temperature

- Operating temperature: 0° to 50° C (32° to 122° F)
- Storage temperature: -20° to 60° C (-4° to 140° F)

Humidity

- Relative humidity: 5% to 90% (RH non-condensing)

External Dimensions

- Length: 166.10 mm (6.53 in)
- Width: 79.60 mm (3.13 in)
- Depth: 43.50 mm (1.71 in)

Weight

- Unit weight: 280 g (9.87 oz)

Processor

- ARM Cortex A9 32-bit processor

Display

- 2.8" QVGA color display
- 240 (RGB) x 320 (dots)

Magnetic Card Reader

- Triple track (tracks 1, 2, 3), high coercivity, bi-directional

Primary Smart Card

- ISO 7816-3, 1.8 V, 3 V, 5 V
- Synchronous and Asynchronous cards
- EMV Approved

SAM Card Reader

- Two Security Access Modules (SAMs)

Security

- 3DES encryption, Master/Session and DUKPT key management
- VeriShield file authentication
- PCI PED 4.0 approved



Troubleshooting Guidelines

This chapter lists typical malfunctions that may occur while operating a P200 device and the appropriate corrective action. If the problem persists – even after performing the outlined guidelines, or if the problem is not described, contact your local Verifone representative for assistance.

NOTE

The P200 device uses a tamper-evident case and contains no user-serviceable parts. Do not, under any circumstance, attempt to disassemble the unit. Perform only those adjustments or repairs specified in this guide. For all other services, contact your local Verifone service provider. Service conducted by parties other than authorized Verifone representatives may void any warranty.

Display Panel Does Not Work

Use the following steps to check the display panel:

- 1 Check all the cable connections.
- 2 Check the controlling device's AC outlet to be sure the outlet is supplying sufficient power. Substitute the controlling device's power pack with another power pack.
- 3 The controlling device's application program might not be loaded correctly. Download the application program and try again.
- 4 If the problem persists, contact your local Verifone representative.

Keypad Does Not Respond

Use the following steps to check the keypad:

- 1 Check the display panel. If there are no characters, or the wrong characters are displayed, refer to [Display Panel Does Not Work](#).
- 2 If the problem persists, contact your local Verifone representative.

Transactions Fail To Process

There are several possible reasons why the unit may not be processing transactions. Use the following steps to troubleshoot failures.

Check Magnetic Card Reader

- Perform a test transaction using one or more different magnetic stripe cards to ensure the problem is not a defective card.
- Ensure that you are swiping cards properly (see [Magnetic Stripe Card Reader Use](#)).
- Process a transaction manually using the keypad instead of the card reader. If the manual transaction works, the problem may be a defective card reader.

- If the problem persists, contact your local Verifone representative.

Check Smart Card Reader

- Perform a test transaction using several different smart cards to ensure the problem is not a defective card.
- Ensure that the card is inserted correctly (see [Magnetic Stripe Card Reader Use](#)).
- Ensure the MSAM cards are properly inserted in the slots and are properly secured (see [MSAM/uSD Cards](#)).
- If the problem persists, contact your local Verifone representative.



Service and Support

Maintenance and Cleaning

The P200 device has no user-serviceable parts. Unless otherwise instructed, do not, under any circumstances, attempt any service, adjustments, or repairs on the unit. Disconnect the device before cleaning.

To clean the unit, periodically use a clean cloth, slightly dampened with water and a drop or two of mild soap. For stubborn stains, use alcohol or an alcohol-based cleaner. For best results, use a Verifone Cleaning Kit (refer to [Accessories and Documentation](#)).



Never use thinner, trichloroethylene, or ketone-based solvents – they can deteriorate plastic or rubber parts.

Because the P200 can be damaged by liquid, do not spray cleaners or other solutions directly onto the keypad or display. Always apply the cleaner to a cloth before cleaning the device.

Service Returns

For P200 equipment failures that cannot be resolved by your help desk or service department, contact one of the following hotlines for product service and repair information:

- USA – Verifone Service and Support Group, 1-800-834-9133, Monday - Friday, 8 A.M. - 7 P.M., EST
- International – Contact your Verifone representative

Before returning P200 unit to Verifone, you must obtain a Merchandise Return Authorization (MRA) number. The following procedure describes how to return one or more P200 for repair or replacement (U.S. customers only).

NOTE



International customers, please contact your local Verifone representative for assistance with your service, return, or replacement.

- 1 Gather the following information from the printed labels on the bottom of *each* P200 device to be returned:
 - Product ID, including the model and part number. For example, “M180-08x-xx-xxx-x”
 - Serial number (S/N xxx-xxx-xxx)
- 2 Within the United States, call Verifone toll-free at 1-800-834-9133.

- 3 Select the MRA option from the automated message. The MRA department is open Monday–Friday, 8 A.M.–7 P.M., EST.
- 4 Give the MRA representative the information gathered in [Step 1](#).
If the list of serial numbers is long, you can fax the list, along with the information gathered in [Step 1](#), to the MRA department at 1-727-953-4172 (U.S.)
 - Please address the fax clearly to the attention of the “Verifone MRA Dept.”
 - Include a telephone number where you can be reached, as well as your fax number.
 - You will be issued MRA number(s) and the fax will be returned to you.

**NOTE**

One MRA number must be issued for each P200 unit you return to Verifone, even if you are returning several of the same model.

- 5 Describe the problem(s).
- 6 Provide the shipping address where the repaired or replacement unit must be returned.
- 7 Keep a record of the following items:
 - Assigned MRA number(s).
 - The serial number assigned to the P200 device (located at the bottom of the unit).
 - Shipping documentation, such as air bill numbers, used to trace the shipment.
 - Model(s) returned (model numbers are located on the bottom of the unit).

Decommissioning/ Removal From Service

The decommissioning procedure applies to P200 and P400 series PCI PTS version 4.x POI-approved devices.

**NOTE**

Failure to use this decommission procedure causes non-compliance to the PCI PTS POI Modular Security Requirements version 4.0 approval of the device.

To securely decommission the device:

- 1 Prepare your tool — a #8 Phillips head screw driver is necessary.
- 2 Ensure that the device is disconnected from power and any other cables.
- 3 Turn the device face down, exposing the rear of the device.

- Using the Phillips head screw driver, remove each of the eight screws. Four of the screws (screw numbers 3, 4, 5, and 6) covered by the rear cable cover. You must remove the cable cover to access these screws.

Screw #4 on the left is covered by a tamper-evident security label. Push the screw driver through this label to access the screw.

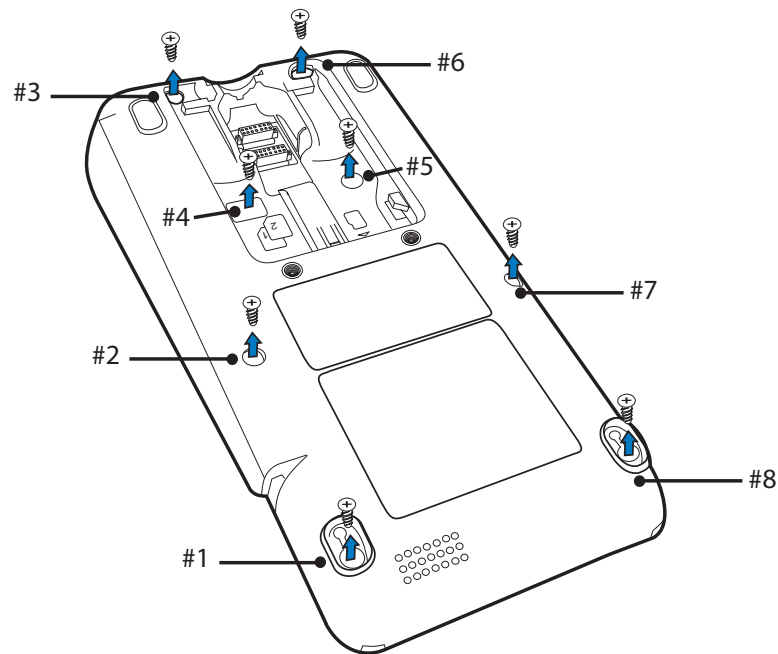

Figure 19 P200 Bottom

- Once all the identified screws have been removed, carefully separate the top housing plastics from the bottom 1mm, then pinch the top and bottom housing back together ensuring proper fit.
- Reinsert all of the screws previously removed. Tighten each screw completely.
- Insert the power cable and power up the device.
- Turn the device face up showing the display and keypad. Verify that the unit is in an "Active Tamper." You should see the *TAMPER* message displayed on the screen.

Accessories and Documentation

Verifone produces accessories and documentation for the P200. When ordering, please refer to the part number in the left column.

- Verifone Online Store at www.store.verifone.com
- USA – Verifone Customer Development Center, 1-800-Verifone (837-4366)
Monday - Friday, 7 A.M. - 5 P.M., MST
- International – Contact your Verifone representative

Cables Contact your local Verifone distributor to determine which cable fits your needs.

CBL280-025-02-A	USB Cable 4.1 m
CBL282-045-XX-A	USB cable (as Device). Powered from +9 V/1 A DC adaptor
CBL282-038-XX-A	USB cable (as Device). Powered from +5 V USB Host.
CBL282-033-01-A	Powered USB cable (as Device). Powered from +12 V PUSB Host
CBL282-031-XX-A	RS-232 cable (DB9). Powered from +12 V DC adaptor.
CBL282-036-XX-A	RS-232 cable (RJ45). Powered from Countertop (+12 V).
CBL282-006-01-B	Cable, VX 820 Ethernet/RS232, Dongle 1.0 m
CBL435-002-01-A	USB cable 2.65 m, connect to P400 to MOD10 port of V200c.
CBL435-005-02-A	P400/P200 Ethernet and Mini-USB Dongle
CBL435-044-01-A	Cable, P400/P200 USB/Ethernet/RS232, Dongle 1.0 m

Power Supply

PWR435-001-01-A	DC power pack (US)
PWR435-001-02-A	DC power pack (UK)
PWR435-001-03-A	DC power pack (EU)
PWR435-001-05-A	DC power pack (Brazil)
PWR435-001-06-A	DC power pack (Australia)
PWR435-001-07-A	DC power pack (South Africa)

Privacy Shield

PPL435-007-01-A	Standard privacy shield
PPL435-013-01-A	Half-height privacy shield

Mounting Plate

PPL435-009-01-A	Optional mounting plate
-----------------	-------------------------

Cleaning Kit

02746-01	Verifone Cleaning Kit
----------	-----------------------

Documentation

<i>P200 and P200 Plus Certifications and Regulations</i>	VPN DOC430-001-EN
<i>P200 Quick Installation Guide</i>	VPN DOC430-002-EN
<i>P200/P400 Reference Guide</i>	VPN DOC435-004-EN
<i>Engage Low-Profile Privacy Shield Quick Installation Guide</i>	VPN DOC000-020-EN
<i>Engage Standard Privacy Shield Quick Installation Guide</i>	VPN DOC000-020-01
<i>P200/P400 Mounting Adapter Quick Installation Guide</i>	VPN DOC435-007-EN



Caution and Warning Messages

Products with UL/cUL certification should include French translations of Caution and Warning notices. The following table lists all notices found in the document, their location, and the equivalent French translations.

Table 4 Caution and Warning Messages

Notice	Chapter	Page	English Text	French Text
Warning	Setup	page 11	For safety, do not string cables or cords across a walkway.	<i>Par mesure de sécurité, ne pas les câbles de chaîne ou de cordons à travers une passerelle.</i>
Caution	Setup	page 11	This unit is not waterproof or dustproof, and is intended for indoor use only. Any damage to the unit from exposure to rain or dust can void any warranty.	<i>Cet appareil n'est pas étanche ou à la poussière, et est destiné à une utilisation en intérieur. Tout dommage à l'unité de l'exposition à la pluie ou à la poussière peut annuler la garantie.</i>
Caution	Setup	page 12,	Using an enclosed metal frame or mount may negatively affect contactless performance.	<i>L'utilisation d'un cadre métallique fermé ou de montage peut affecter négativement contact performance.</i>
Warning	Setup	page 12	Due to risk of electrical shock or terminal damage, do not use the terminal near water, including a bathtub, wash bowl, kitchen sink or laundry tub, in a wet basement, or near a swimming pool. Also, avoid using this product during electrical storms. Avoid locations near electrical appliances or other devices that cause excessive voltage fluctuations or emit electrical noise (for example, air conditioners, neon signs, high frequency or magnetic security devices, or electric motors).	<i>Du fait d'un risque d'électrocution ou d'une détérioration du terminal, ne pas utiliser cet équipement près d'une source d'eau, par exemple près d'une baignoire, d'un lavabo, d'un évier de cuisine ou d'un bac de lavage, dans un sous-sol humide ou à proximité d'une piscine. De même, éviter d'utiliser ce produit lors des orages provoquant des coupures électriques. Éviter de placer le terminal à proximité d'appareils électriques ou autres unités pouvant entraîner des fluctuations de tension importantes ou des interférences électriques, tels que les climatiseurs, enseignes au néon, dispositifs de sécurité à haute fréquence ou équipements électriques.</i>
Caution	Setup	page 13	This device is a secure product and any tampering can cause it to cease to function or operate in an unsecured manner.	<i>Cet appareil est un produit sûr et toute manipulation peut l'amener à cesser de fonctionner ou fonctionner de manière non sécurisée.</i>

Table 4 Caution and Warning Messages (continued)

Notice	Chapter	Page	English Text	French Text
Warning	Setup	page 14	Do not use a unit that has been tampered with or otherwise damaged. This unit comes equipped with tamper-evident label. If a label or component appears damaged, immediately notify the shipping company and your Verifone representative or service provider.	<i>Ne pas utiliser un appareil qui a été altéré ou endommagé. Cet appareil est équipé d'étiquette d'inviolabilité. Si une étiquette ou d'un composant semble être endommagé, en aviser immédiatement la compagnie maritime et votre représentant Verifone ou prestataire de services.</i>
Caution	Setup	page 14	Observe standard precautions in handling electrostatically sensitive devices. Electrostatic discharges can damage the equipment. Verifone recommends using a grounded anti-static wrist strap.	<i>Respecter les précautions standard dans la manipulation d'appareils sensibles aux décharges électrostatiques. Les décharges électrostatiques peuvent endommager le matériel. Verifone recommande d'utiliser un bracelet anti-statique à la terre.</i>
Caution	Setup	page 15	Using an incorrectly rated power supply can damage the unit or cause it not to work properly. Use only a power pack with VPN PWR434-001-01-A.	
Caution	Setup	page 15	Do not plug the power pack into an outdoor outlet or operate the terminal outdoors. Disconnecting power during a transaction can cause transaction data files not yet stored in memory to be lost.	
Warning	Setup	page 16	Turn off or unplug the terminal when connecting or disconnecting the device to avoid device memory corruption and data loss. Refer to the controlling device instructions for any terminal-specific warnings.	<i>Éteignez ou débranchez le terminal pour connecter ou déconnecter le dispositif pour éviter la corruption de la mémoire de l'appareil et la perte de données. Reportez-vous aux instructions de l'appareil de contrôle pour tous les avertissements spécifiques au terminal.</i>
Caution	Setup	page 22	Leave the smart card in the card reader until the transaction is completed. Premature removal can void the transaction.	

Table 4 Caution and Warning Messages (continued)

Notice	Chapter	Page	English Text	French Text
Warning	Setup	page 21	Incorrect power sequence may degrade the SoC Host port.	
Caution	Service and Support	page 31	Never use thinner, trichloroethylene, or ketone-based solvents – they can deteriorate plastic or rubber parts. Because this device can be damaged by liquid, do not spray cleaners or other solutions directly onto the keypad or display. Always apply the cleaner to a cloth before cleaning the device.	<i>N'utilisez jamais de diluant, le trichloréthylène ou des solvants cétoniques - ils peuvent détériorer les pièces en plastique ou en caoutchouc. Parce que cet appareil peut être endommagé par un liquide, ne pas vaporiser de nettoyage ou d'autres solutions directement sur le clavier ou l'écran. Toujours appliquer le nettoyant sur un chiffon avant de nettoyer l'appareil.</i>



Verifone, Inc.
1-800-Verifone
www.verifone.com

P200/P200 Plus

Installation Guide

