

ingenico

Move 5000

User Guide



Optional

www.ingenico.com

13 rue Pagès, 92150 Suresnes – France / (T) +33 (0)1 58 01 80 00

Ingenico - SA au capital de 47 656 332 / 317 218 758 RCS Nanterre



Contents

1. Introduction	4
2. Presentation	5
2.1 Content of the box	5
2.2 Overview on the MOVE/5000	6
2.3 Keyboard details and functionality	8
2.4 Touch panel	9
3. Use of the terminal	10
3.1 Switching off the terminal	10
3.2 Reading card	10
3.3 Scan Engine (Optional)	12
4. Installation	13
4.1 Recommendations	13
4.2 Terminal connections	14
4.2.1 uUSB	14
4.2.2 DC Jack	14
4.2.3 MicroSD memory Card	15
4.2.4 Audio Jack (optional)	15
4.3 Opening trap door	16
4.4 SAMs & SIMs	17

4.5 Battery	18
4.5.1 Main characteristics	18
4.5.2 Installing the battery	18
4.5.3 Charging the battery	20
4.5.4 Changing the battery	21
4.6 Paper roll	22
4.6.1 Main characteristics of INGENICO paper roll	22
4.6.2 Installing paper roll	23
5. Recommendations	24
5.1 Safety	24
5.2 Security of your terminal	25
5.3 Fixed installation	26
6. Standards	28
6.1 Environment (WEEE, Batteries and Packaging)	28
6.2 FCC/IC Compliance	29
6.3 MIC Compliance	33
7. Troubleshooting	34

1. Introduction

We hope that you will be fully satisfied with your new terminal MOVE/5000. This terminal is available in different models. Please select by yourself in this documentation items related to your model.

Read this guide to understand and make the best use of your terminal. It presents you the necessary information about use, installation, maintenance, safety and security recommendations.



WARRANTY / SECURITY

Use only the power supply included with the product to ensure best performance and safety. Maintenance should only be provided by Ingenico authorized technician. Failure to comply with these instructions will void the manufacturer's responsibility.



This symbol indicates an important Warning.



This symbol indicates a piece of advice.

2. Presentation

2.1 Content of the box

- MOVE/5000 terminal unit equipped with a paper roll



- A battery pack disconnected



- Power adapter

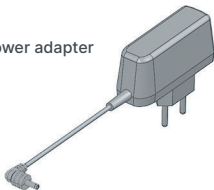

- User guide



WARNING

The power supply unit provided with your equipment is specially designed for Ingenico terminals. Do not use any other power supply. The use of a power supply with apparently similar voltage/current characteristics may damage your terminal.



Keep the packaging. It must be re-used whenever the terminal is shipped

2.2 Overview of the MOVE/5000



Terminal unit

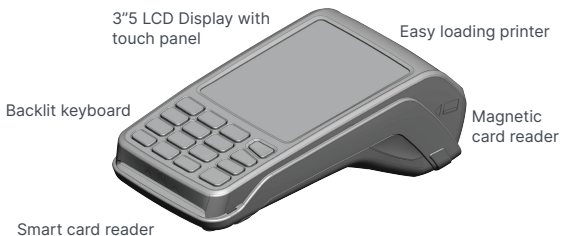

● **Compartment where are located:**

- the battery pack
- the modules SAM1/SAM2/SIM1/SIM2
- the 2nd Smart card reader (optional)



Weight (without paper roll nor battery)	310g
Dimensions (L x w x h)	169×78×57 mm
Electrical mains network	100-240VAC / 50-60 Hz - Class II equipment
Connections on terminal	Micro USB AB serial link Power connector Contacts for Cradle

2.3 Keyboard details and functionality



Some keys can have other functions according to the applications that are in the terminal.



The functions key accesses the different application menus

The red key cancels the procedure in progress

The yellow key cancels the last character

The green key validates input selections and information. It is also used to switch on the terminal

Feed paper a few centimeters if pressed for a long time (more than 2 seconds)

2.4 Touch panel

Move/5000 features touch screen display, allowing user interaction via finger or a stylus. Note that there are 2 different stylus pens depending on the touch screen type, one for Move/5000 with resistive touch screen and one for Move/5000 with capacitive touch screen as shown below :



Resistive stylus



Capacitive stylus



Stylus location

Retractable stylus is located at the back cover as shown above :

3. Use of the terminal





AD-

Before to use the terminal, always check if the roll of paper is present.

3.1 Switching off the terminal

If the battery is empty and the terminal in use is removed from its base, the terminal automatically shuts off.

It may also be switch by pressing simultaneously  and  (yellow key) for one second.

In order to restart the terminal, press  on the keyboard.

3.2 Reading card

Magnetic stripe card

The card can be read either from bottom to top or from top to bottom, with the stripe facing the terminal.

Use a regular movement in order to ensure a reliable card reading.



Smart card

- **Card reader:** insert the card horizontally with the chip facing upwards and leave in position throughout the transaction.



- **2nd card reader (Optional):** is located under terminal trapdoor (on back of the terminal). Insert the card up side down chip facing the terminal.



Contactless (optional)

- Bring the card firmly up to the active zone. Keep the card close to the reader during the transaction
- The 4 virtual LEDs are displayed during the transaction.

The terminal behavior for the cardholder may depend on:

- The terminal environment
- Local usage (language...)



3.3 Scan Engine (Optional)

An optional Camera Autofocus with LED or an optional Barcode module can be fitted on back of Move/5000 terminal (dedicated reference).

About camera feature, 11.16.7B SDK minimum is required to have the benefit of Honeywell® Library.

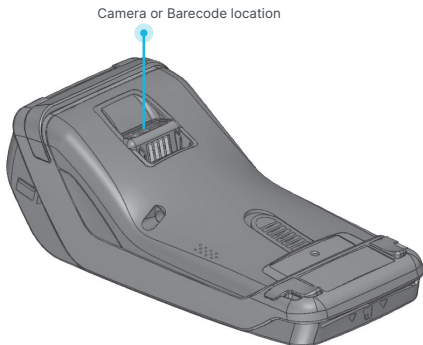

Different formats barcode can be decoded, exhaustive list is given below :

- UPC
- EAN
- CODES 11,39, 93 & 128
- Interleaved 2 of 5
- CODABAR & CODABLOCK
- GS1_DATABAR (RSS) & DATABAR_EXPANDED
- QR_CODE
- DATA_MATRIX
- AZTEC
- PDF417 & Micro PDF 417
- MAXICODE
- POSTAL CODES

If other types of barcode formats have to be decoded, please share your request with your Region Coordination Manager to check the feasibility.

4. Installation

4.1 Recommendations

Location of the Move5000

Place the base on flat surface near an electric socket and according to the base to the telephone or a Ethernet socket. The terminal should be placed far from any very hot zones, protected from vibrations, dust, damp and electromagnetic radiation (computer screen, anti-theft barrier etc.).

Operating conditions

Ambient temperature	from +0°C to +50°C
Max relative humidity	85% at +40°C

Battery charging conditions

Ambient temperature	from +0°C to +50°C
---------------------	--------------------

Storage conditions

Ambient temperature	from -20°C to +55°C
Max relative humidity	85% at +55°C

4.2 Terminal connections

4.2.1 uUSB

- There is an USB connector (microAB) on the left side of the Move/5000 Wireless terminal (see below picture). This connector manages Host and Slave connexions.
- The terminal supports USB Keys with FAT16 or FAT32
- The USB Key has to be used with an USB adapter (refers to accessories section)

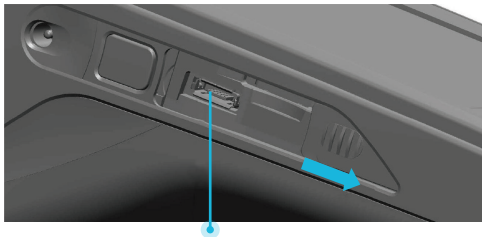

USB micro AB

Connector used for USB Key, etc...

***MicroAB connector durability: up to 10 000 mating cycles**

4.2.2 DC Jack

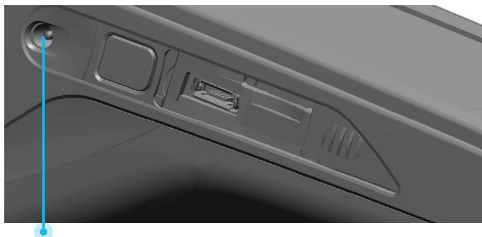

Power Supply Jack

Connector used to plug DC power supply 5V delivered by Ingenico

4.2.3 MicroSD memory Card

- Insert the MicroSD Memory Card into the connector slot as shown on the figure.
- MicroSD connector is located on terminal side.
- The terminal supports MicroSD up to 32GB

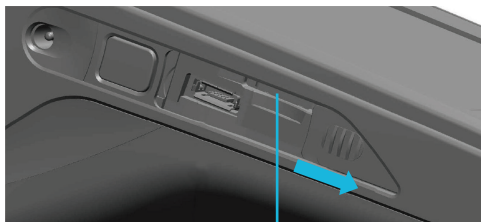

microSD connector

4.2.4 Audio Jack (optional)

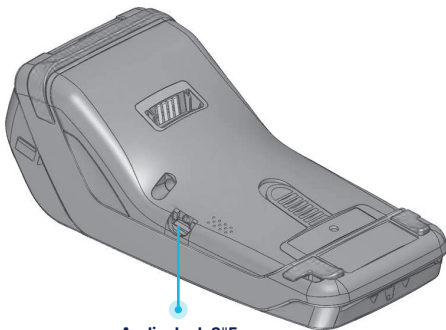

Audio Jack 3"5

4.3 Opening trap door



CAUTION

Switch off the terminal before opening the trapdoor.

- Turn the terminal and unclip the trapdoor by pushing on the clip with as shown with the arrows on the picture



4.4 SAMs & SIMs

The connector modules security SAM/SIM are located inside the terminal, in a closed compartment.

- SAMs and SIMs are identified by the engraved marks on the lower housing
- When introducing a SAM/SIM in its slot, be sure to put the cut corner as indicated on the engraved marks

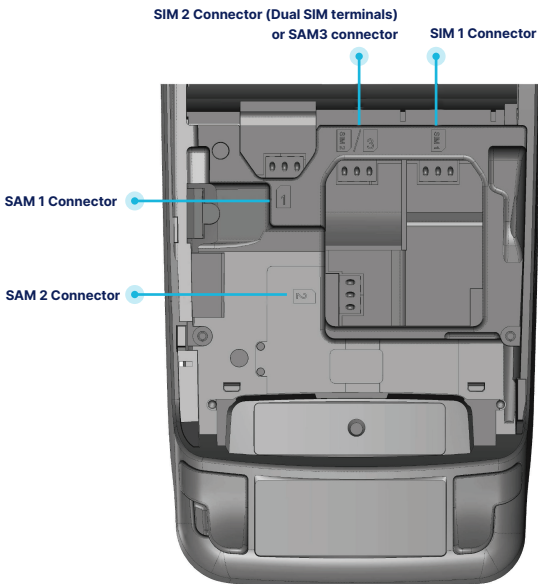

4.5 Battery

4.5.1 Main characteristics

Characteristics	Li-ion 2900 mAh
Charge (power supply-1.5A)	50% capacity in 1,5 h; full capacity in 4 hours
Battery life	<ul style="list-style-type: none">• 450 transactions in GPRS with fully charged battery, printing and backlit activated• Can remain powered ON up to 150 hours with connected GPRS link and terminal in sleeping state starting with fully charged battery and without energy consumption related to backlit or radio link

* The battery capacity depends on the model of terminal and its use

4.5.2 Installing the battery



WARNING

Check that the terminal is not connected to the main electric network.

- Turn your terminal and unclip the battery trapdoor by pushing on the button as shown on the picture
- Disengage the trapdoor
- Take the battery pack included in the box
- Locate the battery pack connector beside the battery compartment
- Plug the battery pack connector **according to the connector locating system and** (as shown on picture).
- Verify that it locks.
- Place the battery pack in its compartment.
- Close the battery compartment trapdoor.



4.5.3 Charging the battery

When does the battery need to be charged?

- On initial start up, charge the battery under the environmental conditions stated above
- When used daily, the terminal recharges its batteries each time it is placed on its base . Charging is automatic
- When used with a terminal power supply: connect the power supply to Move5000 power connector.

How does the battery need to be charged?

- The environment in which the charge takes place influences battery lifetime and autonomy (number of transactions)

The optimal conditions are as follows:

/ Charging away from any external heat source (radiator, sun, enclosed area...)

/ The optimal temperature is between +15°C and +25°C

How can the battery be charged?

Using the base

- Place the terminal on its base
- **Check if the battery symbol is flashing or moving (=battery charging).**



Using the terminal power supply (the terminal is out of its base)

- Connect the terminal power supply unit to use the jack connector located on the left side of the terminal.
- Connect the power supply unit to the power supply mains network
- **Check to see if the battery symbol is flashing or moving(=battery charging)**

4.5.4 Changing the battery



It is imperative to use a battery authorized by Ingenico. There is danger of explosion if battery used is not approved by Ingenico.

- Remove the terminal from its base
- Turn it off by pressing simultaneously  and  (yellow key) for about one second
- Remove the battery trapdoor (see section 4.5.2 “installing battery”)
- Carefully disconnect battery, following the instructions below, For standard battery :

a Unlock the connector by pressing the locking mechanism as indicated by F1 arrow while pulling this connector (F2 arrow). Release traction on it as soon as the connector comes unclipped

b Finish extracting connector by tilting it slightly (F3 arrow) to bring it away from the terminal housing

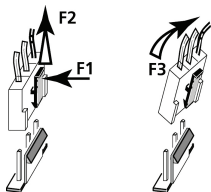

- Following the instructions below for Hardpack battery :

a Unlock the connector by moving up the battery pack latch (F1)

b Finish extracting battery pack by raising slightly the connector to bring battery pack away from the terminal housing. (F2)

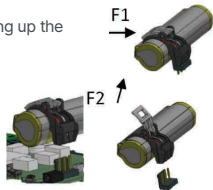

- Connect and install the new battery by following the instructions in section 4.5.2 “Installing battery”
- Close the battery trapdoor and charge the new battery. See section «Charging the Battery»
- In order to preserve the environment, dispose used battery in compliance with current country recycling legislation.

4.6 Paper roll

4.6.1 Mains characteristics of INGENICO paper roll

R40 paper roll Characteristics	Precisions
Colour	White
Width	58 mm
Diameter	40 mm
Length	About 18 metres

- The thermal paper can be deteriorated by poor storage conditions, so we recommend you to avoid:

/ storage in hot wet places (near air-conditioner, humidity higher than 85%)

/ exposure to sunlight or ultraviolet for long periods

/ contact with organic solvents (solvent type adhesive)

/ direct contact with materials containing plasticizers (PVC transparent folders or envelopes)

/ direct contact with «dialzo» papers

/ direct contact with water

/ Rubbing or pressing the paper too strongly



WARNING

For best product performance, **only use heat sensitized paper approved by Ingenico.**



WARNING

Switch off the terminal prior to installing a paper roll.

Use only paper approved by Ingenico.

The use of non approved paper is likely to damage the printer of your terminal.

4.6.2 Installing paper roll

- Open the paper compartment by lifting the catch located at the rear of the terminal and pull the cover to the rear of the terminal.

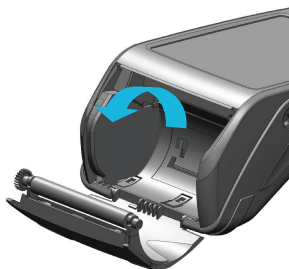

- Insert the paper roll in the compartment following the directions shown on the below picture
- Pull the paper up to the top of the terminal
- Maintain the paper and close the lid
- Press simultaneously on both upper corners of the paper flap, as shown by arrows on picture, until it clips into position

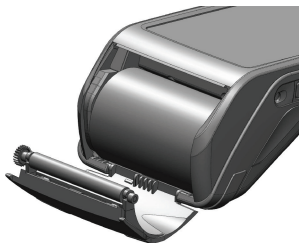



ADVICE

If you insert a new R40 paper roll, tear off the first length (one complete turn to avoid printing on adhesive tape footprint).

5. Recommendations

5.1 Safety

Powering down the Move/5000 :

Disconnect the Move/5000 power supply block adapter from the electrical mains network.

Lithium cell

The Move/5000 is fitted with an internal lithium cell which can only be accessed by a qualified technician.

Battery

Move5000 is fitted with battery specially designed for this terminal.

- Only use the appropriate chargers and batteries listed in the Ingenico's catalogue.
- Do not short-circuit the battery.
- Do not attempt to open the battery container.
- Used batteries must be disposed of at the appropriate sites.



WARNING

There is a risk of explosion if the battery is incorrectly replaced or is placed in a fire.

Electrical power outlet







The electrical outlet must meet the following criteria :

- Must be installed **near the equipment and easily accessible**;
- Must meet standards and regulations in the country where used;
- For type A plug, the protection of the installation must be set to 20 A

SAR exposure

- Maximum SAR value : 1.880 W/kg (LTE FDD I 2100 MHz)
- Maximum simultaneous SAR value : 1.998 W/kg

The power supply label contains seven symbols :

	Double insulation symbol
	DC current output
	AC current input
	DC Power jack polarity
	In door use only
	International Efficiency Marking Protocol (Energy Star Level 5)
	International Efficiency Marking Protocol (Energy Star Level 6)

SAM1/SAM2/SIM1/(SAM3/SIM2) readers compartment

The trapdoor for battery, SAM1/SAM2/SIM1/(SAM3/SIM2), readers located underneath the terminal, must be in place during the normal operation of the terminal. See sections «Removal of SAM1/SAM2/SIM, modules» as well as «Connecting the battery».

On airplanes

Your handset must be switched off by removing the battery pack. Remove the battery from the terminal when on an airplane. Non-compliance with these safety rules may result in legal action and/or a ban on later access to cellular network services.

Explosion areas

Certain regulations restrict the use of radio equipment in chemical plants, fuel depots and any site where blasting is carried out. You are urged to comply with these regulations. The terminal shall be protected by a specially fitted and certified cover enabling use in proximity to a fuel pump.

Electronic health appliances

Your handset is a radio transmitter which may interfere with health appliances, such as hearing aids, pacemaker, hospital equipment, etc.

Your doctor or the equipment manufacturer will be able to provide you with appropriate advice.

External connection

All external circuits connected to the Move/5000 must be SELV (Safety Extra Low Voltage) and LPS (limited power source) within the meaning of section 2.2 and 2.5 of the standard IEC60950-1:2005+/A1:2010 and EN60950-1:2006+/A11:2009+/A1:2010+/A12:2011

Cleaning

To clean the terminal, use a soft cloth slightly moistened with water. Do not clean the electrical connections; do not use solvents, detergents or abrasive products.

5.2 Security of your terminal

Your device fulfils current applicable PCI PTS security requirements.

Upon receipt of your terminal you should check for signs of tampering of the equipment. It is strongly advised that these checks are performed regularly after receipt. You should check, for example: that the keypad is firmly in place; that there is no evidence of unusual wires that have been connected to any ports on your terminal or associated equipment, the chip card reader or any other part of your terminal. Such checks would provide warning of any unauthorised modifications to your terminal, and other suspicious behaviour of individuals that have access to your terminal. Your terminal detects any "tampered state". In this state the terminal will repeatedly flash the message "Alert Irruption!" and further use of the terminal will not be possible. If you observe the "Alert Irruption!" message, you should contact the terminal helpdesk immediately.

You are strongly advised to ensure that privileged access to your terminal is only granted to staff that have been independently verified as being trustworthy.

The terminal must never be put in or left at a location where it could be stolen or replaced by another device.

5.3 Fixed installation

If the device is to be used in a situation where it is not possible for the cardholder to pick up and shield their PIN entry themselves, the device may be used without PIN shield, but it must be installed in the following manner:

- a) The device must be angled at 45 or more, so that oversight of the PIN entry from the rear of the device is not possible.
- b) The device must either be fitted in a swivel stand – so that the customer can position the device in the best angle to prevent oversight – or the device must be fixed in the best possible position to prevent oversight if such a generic position exists in the specific environment to which the device is installed.
- c) The device environment must be accompanied with conspicuous notices and educational material which informs the customer to shield their PIN during PIN entry.
- d) The device must be deployed so that oversight from other customers, either in different payment lanes, or in other areas of the shopping environment, is prevented. This may be achieved through the placement of the lanes and device, so that the customer is automatically positioned between the device keypad and other customers. Alternatively, it may be achieved by the environment in which the device is installed, so that the checkout itself shields the PIN entry process.
- e) The terminal is exclusively made for indoor use.

If the above conditions are not fulfilled, the device with PIN shield must be used.



CAUTION

Positioning of the terminal on check stand must be in such a way to make cardholder PIN (Personal Identification Number) spying infeasible.

Installing device on an adjustable stand must be in such a way that consumers can swivel the terminal sideways and/ or tilt it forwards/backwards to a position that makes visual observation of the PIN-entry process difficult.

Positioning of in-store security cameras such that the PIN-entry keypad is not visible.

NEVER ask the customer to divulge their PIN Code. Customers should be advised to ensure that they are not being overlooked when entering their PIN Code.

6. Standards

6.1 Environment (WEEE, Batteries and Packaging)

This product is labeled in accordance with European Directives 2002/96/EC concerning Waste Electrical and Electronic Equipment (WEEE) and 2006/66/EC concerning Batteries and Accumulators. Those provisions are requiring producers and manufacturers to become liable for take-back, treatment and recycling upon end of life of equipment and batteries.



The associated symbol means that WEEE and waste batteries must not be thrown away but collected separately and recycled.

Ingenico ensures that efficient collection and recycling schemes are set-up for WEEE and batteries according to the local regulation of your country. Please contact your retailers for more detailed information about the compliance solution in place for disposing of your old product and used batteries.

Packaging waste must also be collected separately to assure a proper disposal and recycling.

Please note that proper recycling of the electrical and electronic equipment and waste batteries will ensure safety of human health and environment.

6.2 FCC/IC Compliance

- You are cautioned that changes or modifications not expressly approved by the part responsible for compliance could void the user's authority to operate the equipment.
- This equipment has been tested and found to comply with the limits for a Class B digital device, pursuant to part 15 of the FCC Rules. These limits are designed to provide reasonable protection against harmful interference in a residential installation. This equipment generates, uses and can radiate radio frequency energy and, if not installed and used in accordance with the instruction, may cause harmful interference to radio communications. However, there is no guarantee that interference will not occur in a particular installation. If this equipment does cause harmful interference to radio or television reception which can be determined by turning the equipment off and on, the user is encouraged to try to correct interference by one or more of the following measures :
 - Reorient or relocate the receiving antenna.
 - Increase the separation between the equipment and receiver.
 - Connect the equipment into an outlet on circuit different from that to which the receiver is connected.
 - Consult the dealer or an experienced radio/TV technician for help.
- This device complies with Part 15 of the FCC Rules and Industry Canada license-exempt RSS standard(s). Operation is subject to the following two conditions:
 - (1) This device may not cause harmful interference, and
 - (2) This device must accept any interference received, including interference that may cause undesired operation.
- Le présent appareil est conforme aux CNR d'Industrie Canada applicables aux appareils radio exempts de licence. L'exploitation est autorisée aux deux conditions suivantes :
 - (1) l'appareil ne doit pas produire de brouillage, et
 - (2) l'utilisateur de l'appareil doit accepter tout brouillage radioélectrique subi, même si le brouillage est susceptible d'en compromettre le fonctionnement.

- Under Industry Canada regulations, this radio transmitter may only operate using an antenna of a type and maximum (or lesser) gain approved for the transmitter by Industry Canada. To reduce potential radio interference to other users, the antenna type and its gain should be so chosen that the equivalent isotropically radiated power (e.i.r.p.) is not more than that necessary for successful communication.
- Conformément à la réglementation d'Industrie Canada, le présent émetteur radio peut fonctionner avec une antenne d'un type et d'un gain maximal (ou inférieur) approuvé pour l'émetteur par Industrie Canada. Dans le but de réduire les risques de brouillage radioélectrique à l'intention des autres utilisateurs, il faut choisir le type d'antenne et son gain de sorte que la puissance isotrope rayonnée équivalente (p.i.r.e.) ne dépasse pas l'intensité nécessaire à l'établissement d'une communication satisfaisante.
- No changes shall be made to the equipment without the permission of Ingenico as this may void the user's authority to operate the equipment.
- Tout changement apporté à ce terminal non expressément approuvé par Ingenico est susceptible d'annuler le droit de l'utilisateur à se servir de cet équipement.
- This product meets the applicable Innovation, Science and Economic Development Canada technical specifications. The Ringer Equivalence Number (REN) indicates the maximum number of devices allowed to be connected to a telephone interface. The termination of an interface may consist of any combination of devices subject only to the requirement that the sum of the RENs of all the devices not exceed five. REN for this device is 0.1.
- Le présent appareil est conforme aux spécifications techniques applicables d'Innovation, Sciences et Développement économique Canada. L'indice d'équivalence de la sonnerie (IES) sert à indiquer le nombre maximal de dispositifs qui peuvent être raccordés à une interface téléphonique. La terminaison d'une interface peut consister en une combinaison quelconque de dispositifs, à la seule condition que la somme des IES de tous les dispositifs n'exécède pas cinq. L'IES pour cet appareil est de 0.1.
- The device for operation in the band 5150–5250 MHz is only for indoor use to reduce the potential for harmful interference to co-channel mobile satellite systems. In addition, high-power radars are allocated as primary users (i.e. priority users) of the bands 5250–5350 MHz and 5650–5850 MHz and that these radars could cause interference and/or damage to LE-LAN devices.

- Les dispositifs fonctionnant dans la bande de 5 150 à 5 250 MHz sont réservés uniquement pour une utilisation à l'intérieur afin de réduire les risques de brouillage préjudiciable aux systèmes de satellites mobiles utilisant les mêmes canaux. D'autre part, les utilisateurs de radars de haute puissance sont désignés utilisateurs principaux (c.-à-d., qu'ils ont la priorité) des bandes de 5250 à 5350 MHz et de 5650 à 5850 MHz et, d'autre part, que ces radars pourraient causer du brouillage et/ou des dommages aux dispositifs de RL-EL.

Part 68 of FCC Rules

Model Name

Product : Move/Base Eth/Mod/BT

US MODEM

US : IEOMM01BM5000

This equipment complies with Part 68 of the FCC rules and the requirements adopted by the ACTA. On the bottom of this equipment is a label that contains, among other information, a product identifier in the format US : AAAEQ##TXXXX. If requested, this number must be provided to the telephone company.

This equipment uses the following USOC jacks : (RJ11C).

A plug and jack used to connect this equipment to the premises wiring and telephone network must comply with the applicable FCC Part 68 rules and requirements adopted by the ACTA. A compliant telephone cord and modular plug is provided with this product. It is designed to be connected to a compatible modular jack that is also compliant. See installation instructions for details.

The REN is used to determine the number of devices that may be connected to a telephone line. Excessive RENs on a telephone line may result in the devices not ringing in response to an incoming call. In most but not all areas, the sum of RENs should not exceed five (5.0). To be certain of the number of devices that may be connected to a line, as determined by the total RENs, contact the local telephone company.

If this equipment causes harm to the telephone network, the telephone company will notify you in advance that temporary discontinuance of service may be required. If advance notice is not practical, the telephone company will notify the customer as soon as possible.

Also, you will be advised of your right to file a complaint with the FCC if you believe it is necessary.

The telephone company may make changes in its facilities, equipment, operations, or procedures that could affect the operation of this equipment. If this happens, the telephone company will provide advance notice in order for you to make the necessary modifications to maintain uninterrupted service.

If trouble is experienced with this equipment, please contact INGENICO, or your local INGENICO distributor or service center in the U.S.A. for repair and/or warrant information.

If your home has specially wired alarm equipment connected to the telephone line, ensure the installation of this equipment does not disable your alarm equipment. If you have questions about what will disable alarm equipment, consult your telephone company or a qualified installer.

U.S.A service center:
Ingenico North America
3025 Windward Plaza, suite 600
Alpharetta, GA 30005
USA

Tel: +1(678) 456 1200
Email: info.us@ingenico.com

6.3 MIC Compliance

Japanese Radio Law and Japanese Telecommunications Business Law Compliance.

This device is granted pursuant to the Japanese Radio Law (電波法) and the Japanese Telecommunications Business Law (電気通信事業法). This device should not be modified (otherwise the granted designation number will become invalid).

MIC/KS

総務省指定
第AC-17194号



202-LSH015



D 19-0009 202

7. Troubleshooting

The terminal does not turn on

- Check the battery (is it discharged ?, is it connected ?)
A full discharged battery can take long charging time to recover
- Connect terminal to terminal power supply or put it on powered base

Cards are not read

- Check that the magnetic card is swiped correctly (with magnetic band on terminal side).
- Swipe again the card with the magnetic stripe movement constant and rapid
- Verify that the magnetic strip is not damaged, grooved or cracked
- Make sure you have inserted correctly the smart card into the smart card reader and removed the card only after the transaction is performed.

The ticket is not printed

- Check the presence and proper positioning of the paper roll.
Possibly adjust the paper roll following the instructions in this manual (section 0 "Installing the paper roll")
- Check the type of paper used (thermal paper must be used)
- Verify thermal paper sensitive side.

NOTES

“This Document is Copyright © 2021 by INGENICO Group. INGENICO retains full copyright ownership, rights and protection in all material contained in this document. The recipient can receive this document on the condition that he will keep the document confidential and will not use its contents in any form or by any means, except as agreed beforehand, without the prior written permission of INGENICO. Moreover, nobody is authorized to place this document at the disposal of any third party without the prior written permission of INGENICO. If such permission is granted, it will be subject to the condition that the recipient ensures that any other recipient of this document, or information contained therein, is held responsible to INGENICO for the confidentiality of that information.

Care has been taken to ensure that the content of this document is as accurate as possible. INGENICO however declines any responsibility for inaccurate, incomplete or outdated information. The contents of this document may change from time to time without prior notice, and do not create, specify, modify or replace any new or prior contractual obligations agreed upon in writing between INGENICO and the user.

INGENICO is not responsible for any use of this device, which would be non consistent with the present document.

All trademarks used in this document remain the property of their rightful owners.”

Your contact



www.ingenico.com

13 rue Pagès, 92150 Suresnes – France / (T) +33 (0)1 58 01 80 00
Ingenico - SA au capital de 47 656 332 / 317 218 758 RCS Nanterre